



TRAIDENIS
20 years

**TANKS FROM GLASS – FIBRE
REINFORCED PLASTIC (GRP)**
(Flanges, manholes, insulation and etc.)



PRODUCTION AND TECHNOLOGICAL SERVICES

TABLE OF CONTENTS

	Company profile	3
	Production technology	4
	Configuration & size	5
	Vertical tank configuration	7
	Horizontal tank configuration	8
	Manholes	9
	Flanges types & dimensions	11
	Components	13
	Anchorage systems for vertical tanks	14
	Support saddles for horizontal tanks	15
	Double wall	16
	Insulation	17
	Electric heaters	18
	Heating cable	19
	Coils heating and temperature permanence	20
	Rails and ladders	21
	Dome-shaped modular roofs	22
	Modular tanks	23
	Closed recirculating system for fish farming	25
	Custom items	26
	Finishing	27
	Portfolio	28
	Inquiry form	29

Company *Traidenis*, first producer of wastewater treatment equipment and tanks from glass-reinforced plastic (GRP) in Lithuania, was established in 1996.



TRAIDENIS is:

- a company of production and technological services;
- science, knowledge, innovations ("know - how");
- an international company network;
- a modern production - technological base.



The main products designed, produced and sold by Traidenis are:

- Single skin and multiple skin tanks
- Chemically resistant tanks
- Silo tanks
- Scrubbers
- Tanks for storage of fuel
- Tanks for drinking water
- Thermo-insulated tanks
- Modular tanks up to 5000 m³
- Dome-shaped modular roofs
- Firewater reservoirs
- Piping
- Special works in fibreglass
- Thermo - pool
- Closed recirculating system for fish farming



Certificate of conformity of production control



ISO 9001:2008



ISO 14001:2004

Production of the company is manufactured in the state-of-the-art fitted moulding and assembly workshops, applying the most up-to-date manufacture technologies.

The company has an automated management of processes and production – an installed IT system *Monitor*.

Products from GRP are made by using:

- Filament winding, Spray - up, Hand lay up and Vacuum technologies;
- Industrial robot for part's trimming and drilling.



Filament winding technology



Spray – up technology



Vacuum technology



Industrial robot

VT
Vertical tank
with flat bottom

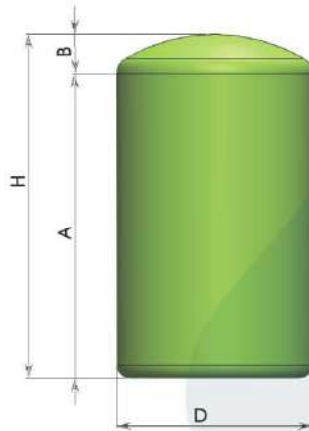

- A** - cylindrical part height
- B** - bottom or top end height
- D** - diameter
- H** - total height

VTL
Vertical tank on legs
Optional legs:

- GRP
- Steel

- A** - cylindrical part height
- B** - bottom or top end height
- D** - diameter
- H** - total height
- L** - cylindrical part height with bottom or top end height

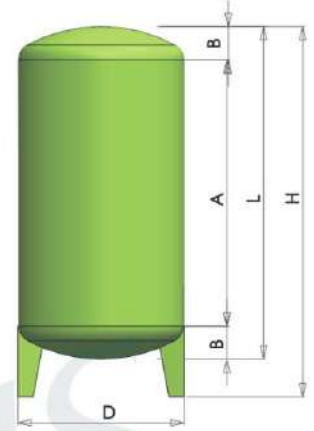

	D	Vol.	L		D	Vol.	L		D	Vol.	L		D	Vol.	L
Ø1200				Ø3000				Ø1200				Ø3000			
VT.1	1200	1	1,0	VT.30	3000	30	4,5	VTL.1	1200	1	1,0	VTL.30	3000	30	4,7
VT.2	1200	2	1,9	VT.40	3000	40	5,9	VTL.2	1200	2	1,9	VTL.40	3000	40	6,1
VT.5	1200	5	4,5	VT.60	3000	60	8,7	VTL.5	1200	5	4,6	VTL.60	3000	60	8,9
VT.10	1200	10	8,9	VT.80	3000	80	11,5	VTL.10	1200	10	9,0	VTL.80	3000	80	11,7
VT.15	1200	15	13,4	VT.100	3000	100	14,4	VTL.13	1200	15	13,4	VTL.100	3000	100	14,6
Ø1500				Ø3600				Ø1500				Ø3600			
VT.2	1500	2	1,2	VT.40	3600	40	4,2	VTL.2	1500	2	1,3	VTL.40	3600	40	4,4
VT.5	1500	5	2,9	VT.50	3600	50	5,2	VTL.5	1500	5	3,0	VTL.50	3600	50	5,4
VT.10	1500	10	5,8	VT.60	3600	60	6,2	VTL.10	1500	10	5,8	VTL.60	3600	60	6,4
VT.15	1500	15	8,6	VT.80	3600	80	8,1	VTL.15	1500	15	8,7	VTL.80	3600	80	8,4
VT.20	1500	20	11,4	VT.100	3600	100	10,1	VTL.20	1500	20	11,5	VTL.100	3600	100	10,3
Ø1800				VT.120	3600	120	12,1	Ø1800				VTL.120	3600	120	12,3
VT.5	1800	5	2,1	VT.140	3600	140	14,0	VTL.2	1800	2	1,0	VTL.140	3600	140	14,3
VT.10	1800	10	4,0	Ø4000				VTL.5	1800	5	2,2	Ø4000			
VT.15	1800	15	6,0	VT.30	4000	30	3,3	VTL.10	1800	10	4,2	VTL.30	4000	30	2,9
VT.20	1800	20	8,0	VT.40	4000	40	4,1	VTL.15	1800	15	6,1	VTL.40	4000	40	3,7
VT.25	1800	25	9,9	VT.60	4000	60	5,7	VTL.20	1800	20	8,1	VTL.60	4000	60	5,3
VT.30	1800	30	11,9	VT.80	4000	80	7,2	VTL.25	1800	25	10,1	VTL.80	4000	80	6,9
Ø2100				VT.100	4000	100	8,8	VTL.30	1800	30	12,0	VTL.100	4000	100	8,5
VT.10	2100	10	3,0	VT.120	4000	120	10,4	Ø2100				VTL.120	4000	120	10,1
VT.15	2100	15	4,5	VT.140	4000	140	12,0	VTL.5	2100	5	1,7	VTL.140	4000	140	11,7
VT.20	2100	20	5,9	VT.160	4000	160	13,6	VTL.10	2100	10	3,2	VTL.160	4000	160	13,3
VT.25	2100	25	7,4	VT.180	4000	180	15,2	VTL.15	2100	15	4,6	VTL.180	4000	180	14,9
VT.30	2100	30	8,8	Ø5000				VTL.20	2100	20	6,1				
VT.35	2100	35	10,3	VT.60	5000	60	3,4	VTL.25	2100	25	7,5				
VT.40	2100	40	11,7	VT.80	5000	80	4,4	VTL.30	2100	30	9,0				
Ø2400				VT.100	5000	100	5,5	VTL.35	2100	35	10,4				
VT.10	2400	10	2,4	VT.120	5000	120	6,5	VTL.40	2100	40	11,8				
VT.15	2400	15	3,5	VT.140	5000	140	7,5	Ø2400							
VT.20	2400	20	4,6	VT.160	5000	160	8,5	VTL.5	2400	5	1,4				
VT.25	2400	25	5,7	VT.180	5000	180	9,5	VTL.10	2400	10	2,5				
VT.30	2400	30	6,8	VT.200	5000	200	10,5	VTL.15	2400	15	3,7				
VT.35	2400	35	7,9	VT.220	5000	220	11,6	VTL.20	2400	20	4,8				
VT.40	2400	40	9,0	VT.240	5000	240	12,6	VTL.25	2400	25	5,9				
VT.45	2400	45	10,1	VT.260	5000	260	13,6	VTL.30	2400	30	7,0				
VT.50	2400	50	11,2	VT.280	5000	280	14,6	VTL.35	2400	35	8,1				

All tanks can be manufactured for intermediate capacities.

HT-U

Horizontal underground tank

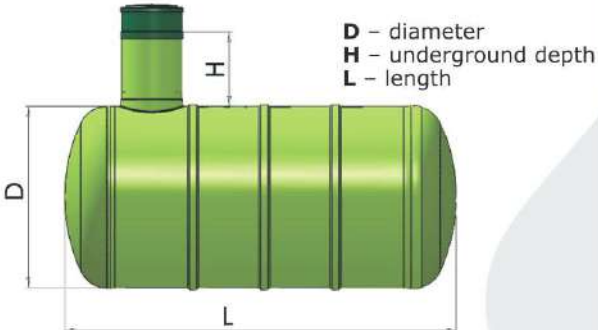

HT-O

Horizontal overground tank

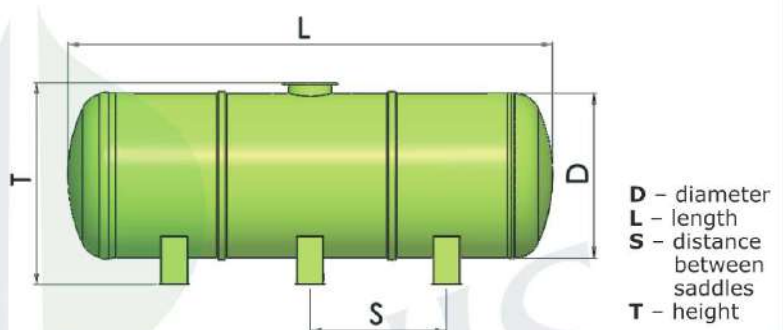













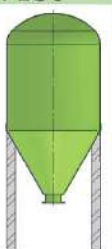

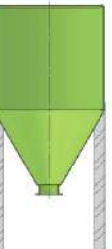

	D	Vol.	L		D	Vol.	L		D	Vol.	L		D	Vol.	L
Ø1200				Ø2400				Ø3600				Ø5000			
TP.1	1200	1	1,0	TP.5	2400	5	1,4	TP.15	3600	15	2,0	TP.40	5000	40	2,7
TP.2	1200	2	1,9	TP.10	2400	10	2,5	TP.20	3600	20	2,5	TP.50	5000	50	3,3
TP.5	1200	5	4,6	TP.15	2400	15	3,7	TP.30	3600	30	3,5	TP.60	5000	60	3,8
TP.10	1200	10	9,0	TP.20	2400	20	4,8	TP.40	3600	40	4,4	TP.70	5000	70	4,3
TP.15	1200	15	13,4	TP.25	2400	25	5,9	TP.50	3600	50	5,4	TP.80	5000	80	4,8
TP.20	1200	20	17,9	TP.30	2400	30	7,0	TP.60	3600	60	6,4	TP.90	5000	90	5,3
Ø1500				TP.35	2400	35	8,1	TP.70	3600	70	7,4	TP.100	5000	100	5,8
TP.2	1500	2	1,3	TP.40	2400	40	9,2	TP.80	3600	80	8,4	TP.110	5000	110	6,3
TP.5	1500	5	3,0	TP.45	2400	45	10,3	TP.90	3600	90	9,4	TP.120	5000	120	6,8
TP.10	1500	10	5,8	TP.50	2400	50	11,4	TP.100	3600	100	10,3	TP.130	5000	130	7,3
TP.15	1500	15	8,7	TP.55	2400	55	12,5	TP.110	3600	110	11,3	TP.140	5000	140	7,8
TP.20	1500	20	11,5	TP.60	2400	60	13,6	TP.120	3600	120	12,3	TP.150	5000	150	8,4
TP.25	1500	25	14,3	TP.65	2400	65	14,7	TP.130	3600	130	13,3	TP.160	5000	160	8,9
TP.30	1500	30	17,2	TP.70	2400	70	15,8	TP.140	3600	140	14,3	TP.170	5000	170	9,4
Ø1800				Ø3000				TP.150	3600	150	15,3	TP.180	5000	180	9,9
TP.2	1800	2	1,0	TP.10	3000	10	1,8	TP.160	3600	160	16,2	TP.190	5000	190	10,4
TP.5	1800	5	2,2	TP.15	3000	15	2,5	Ø4000				TP.200	5000	200	10,9
TP.10	1800	10	4,2	TP.20	3000	20	3,3	TP.20	4000	20	2,1	TP.210	5000	210	11,4
TP.15	1800	15	6,1	TP.25	3000	25	4,0	TP.30	4000	30	2,9	TP.220	5000	220	11,9
TP.20	1800	20	8,1	TP.30	3000	30	4,7	TP.40	4000	40	3,7	TP.230	5000	230	12,4
TP.25	1800	25	10,1	TP.35	3000	35	5,4	TP.50	4000	50	4,5	TP.240	5000	240	12,9
TP.30	1800	30	12,0	TP.40	3000	40	6,1	TP.60	4000	60	5,3	TP.250	5000	250	13,4
TP.35	1800	35	14,0	TP.45	3000	45	6,8	TP.70	4000	70	6,1	TP.260	5000	260	14,0
TP.40	1800	40	16,0	TP.50	3000	50	7,5	TP.80	4000	80	6,9	TP.270	5000	270	14,5
Ø2100				TP.55	3000	55	8,2	TP.90	4000	90	7,7	TP.280	5000	280	15,0
TP.5	2100	5	1,7	TP.60	3000	60	8,9	TP.100	4000	100	8,5	TP.290	5000	290	15,5
TP.10	2100	10	3,2	TP.65	3000	65	9,6	TP.110	4000	110	9,3	TP.300	5000	300	16,0
TP.15	2100	15	4,6	TP.70	3000	70	10,3	TP.120	4000	120	10,1				
TP.20	2100	20	6,1	TP.75	3000	75	11,0	TP.130	4000	130	10,9				
TP.25	2100	25	7,5	TP.80	3000	80	11,7	TP.140	4000	140	11,7				
TP.30	2100	30	9,0	TP.85	3000	85	12,5	TP.150	4000	150	12,5				
TP.35	2100	35	10,4	TP.90	3000	90	13,2	TP.160	4000	160	13,3				
TP.40	2100	40	11,8	TP.95	3000	95	13,9	TP.170	4000	170	14,1				
TP.45	2100	45	13,3	TP.100	3000	100	14,6	TP.180	4000	180	14,9				
TP.50	2100	50	14,7	TP.105	3000	105	15,3	TP.190	4000	190	15,7				
TP.55	2100	55	16,2	TP.110	3000	110	16,0	TP.200	4000	200	16,5				



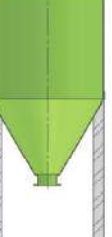

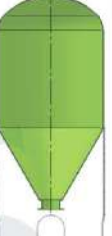

S, H, T - according to the customer requirements.

Flanges/manholes, their quantity, size and orientation are optional. Higher capacities are possible.

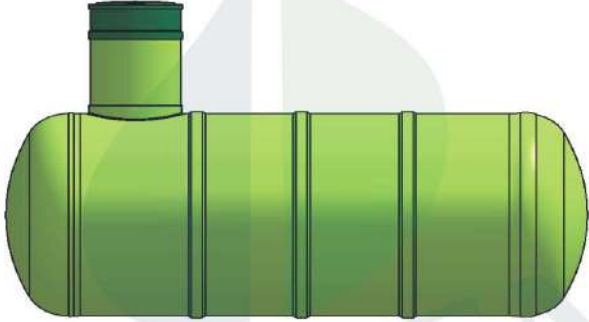
VERTICAL TANK

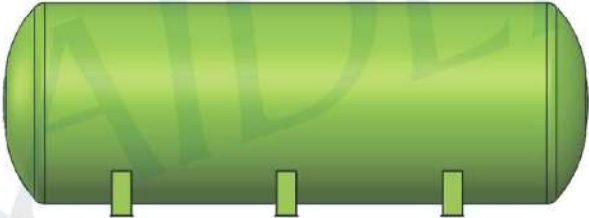
VT	Vertical flat bottom tank Ø800÷Ø5000	VTL	Vertical tank with GRP legs Ø1200÷Ø5000	VTLS	Vertical tank with steel legs Ø1200÷Ø5000	VTS	Vertical tank with GRP skirt Ø1200÷Ø5000	SIL	Conical bottom silos Ø1200÷Ø5000 35°÷150°
VT		VTL Dome top ant bottom		VTLS Dome top		VTS Dome top		SIL Dome top	
VT-SB	Slope bottom 	VTL-F Flat top		VTLS-F Flat top		VTS-F Flat top		SIL-F Flat top	
VT-O	Open top 	VTL-O Open top		VTLS-O Open top		VTS-O Open top		SIL-O Open top	
VT-F	Flat top 	VTL-ST Slope top		VTLS-C Custom support		VTS-ST Slope top		SIL-S GRP Skirt	

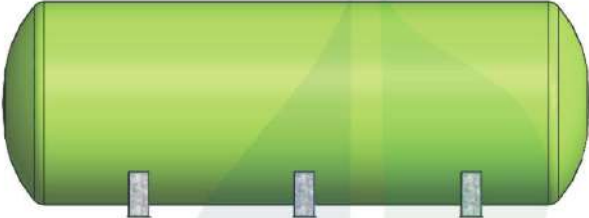

HT	Horizontal tanks		
	Ø800 ÷ Ø5000		
HT-U Underground			
HT-UG - GS Overground with grp saddles			
HT-UG - SS Overground with steel saddles			



Manhole



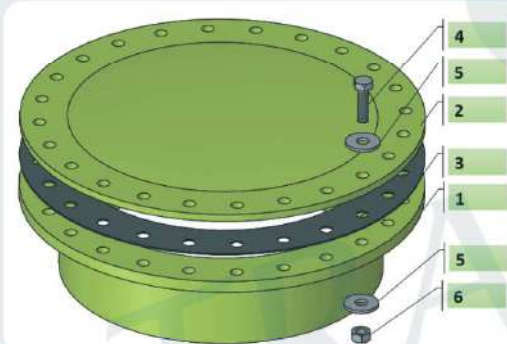
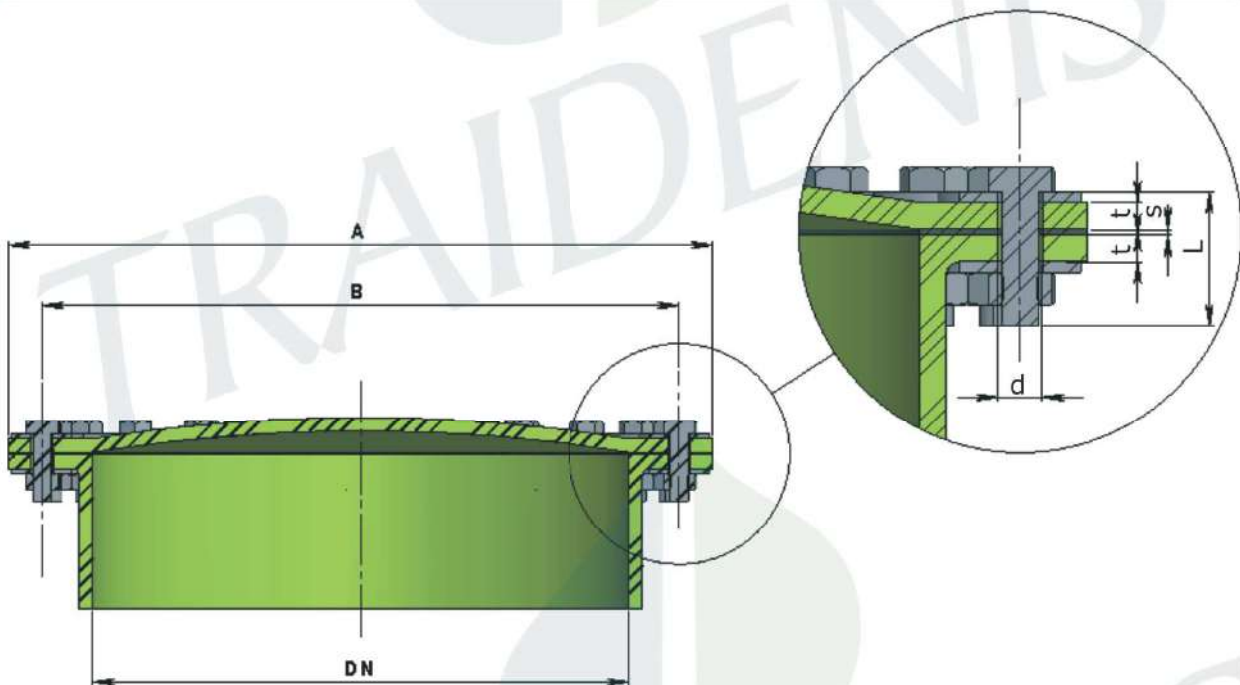













	DN	400	500	600	800
Diameters (mm)	A	540	645	755	975
	B	495	600	705	920
Holes	N°	16	20	20	24
	d	22	22	26	30
Thickness (mm)	t	30	30	35	35
	s	3	3	3	3
Bolts		N°16 M20	N°20 M20	N°20 M24	N°24 M27
	L	90	90	100	100



Specification			
Nr.	Title	Qty	Material
1	Flange DN800	1	GRP
2	Cover DN800	1	GRP
3	Gasket DN800	1	EPDM
4	Bolt	24	AISI304
5	Washer	48	AISI304
6	Nut	24	AISI304

- The following drilling standard is available EN 1092-1:2007 (E).
- The gasket must be flat and drilled. Material: EPDM. On request other materials are available.
- The bolts are according to DIN933.
- The washers are according to DIN9021.
- The nuts are according to DIN934.
- The bolt torque are according to EN 13121-3







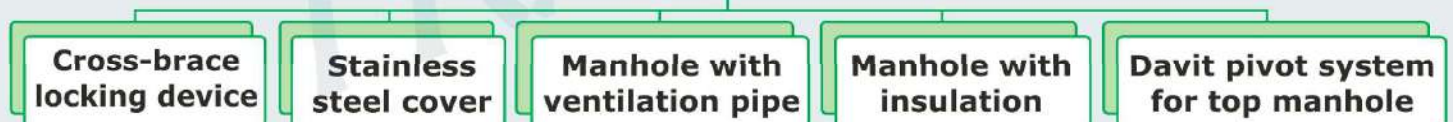

MANHOLES TYPE

MF	Flanged manhole <i>on top or on side</i>	DN500 - DN2000		
MH	Manhole with handles <i>on side</i>	DN500 - DN2000		
MD	Davit pivot system for side manhole <i>on side</i>	DN500 - DN2000		
MIL	Manhole with inspection lid <i>on top</i>	DN500 - DN2000		
MI	Inspection manhole <i>on top</i>	DN500 - DN2000		
MG	Manhole with glass <i>on top or on side</i>	DN500 - DN2000		
MR	Rectangle manhole	According to customer's requirements		
MRC	Rectangle manhole with cover	According to customer's requirements		

POSSIBLE ADDITIONAL ELEMENTS*

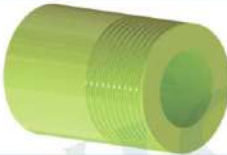

*On request other types, dimensions and standards are available.

Flanges & sockets			
F	Flange	DN15 – DN2000	
FG	Flange with gussets	if necessary	
FL	Loose flange	DN 15 – DN600	
FB	Blind flange	DN 15 – DN2000	
FP	Flange with pin	DN 15 – DN2000	
FPG	Flange with pin and glass	DN250– DN	
SI	Socket with internal thread	1/4" - 4"	
SE	Socket with external thread	1/4" - 4"	



1. The flanges are according to EN 1092-1:2007 (E).
2. The sockets are according to DIN ISO 228-1.
3. On request other types, dimensions and standards are available.

Detailed flanges dimensions EN 1092 - 1 :2007 (E)

DN		PN6					PN10					PN16				
INCHES	MM	FLANGE DIAMETER	HOLES			BOLTS DIAMETER	FLANGE DIAMETER	HOLES			BOLTS DIAMETER	FLANGE DIAMETER	HOLES			BOLTS DIAMETER
			CENTER	NUMBER	DIAMETER			CENTER	NUMBER	DIAMETER			CENTER	NUMBER	DIAMETER	
1/2"	15	80	55	4	11	10	95	65	4	14	12	95	65	4	14	12
3/4"	20	90	65	4	11	10	105	75	4	14	12	105	75	4	14	12
1"	25	100	75	4	11	10	115	85	4	14	12	115	85	4	14	12
1 1/4"	32	120	90	4	14	12	140	100	4	18	16	140	100	4	18	16
1 1/2"	40	130	100	4	14	12	150	110	4	18	16	150	110	4	18	16
2"	50	140	110	4	14	12	165	125	4	18	16	165	125	4	18	16
2 1/2"	65	160	130	4	14	12	185	145	8	18	16	185	145	8	18	16
3"	80	190	150	4	18	16	200	160	8	18	16	200	160	8	18	16
4"	100	210	170	4	18	16	220	180	8	18	16	220	180	8	18	16
5"	125	240	200	8	18	16	250	210	8	18	16	250	210	8	18	16
6"	150	265	225	8	18	16	285	240	8	22	20	285	240	8	22	20
8"	200	320	280	8	18	16	340	295	8	22	20	340	295	12	22	20
10"	250	375	335	12	18	16	395	350	12	22	20	405	355	12	26	24
12"	300	440	395	12	22	20	445	400	12	22	20	460	410	12	26	24
14"	350	490	445	12	22	20	505	460	16	22	20	520	470	16	26	24
16"	400	540	495	16	22	20	565	515	16	26	24	580	525	16	30	27
18"	450	595	550	16	22	20	615	565	20	26	24	640	585	20	30	27
20"	500	645	600	20	22	20	670	620	20	26	24	715	650	20	33	30
24"	600	755	705	20	26	24	780	725	20	30	27	840	770	20	36	33

Customer selects if necessary

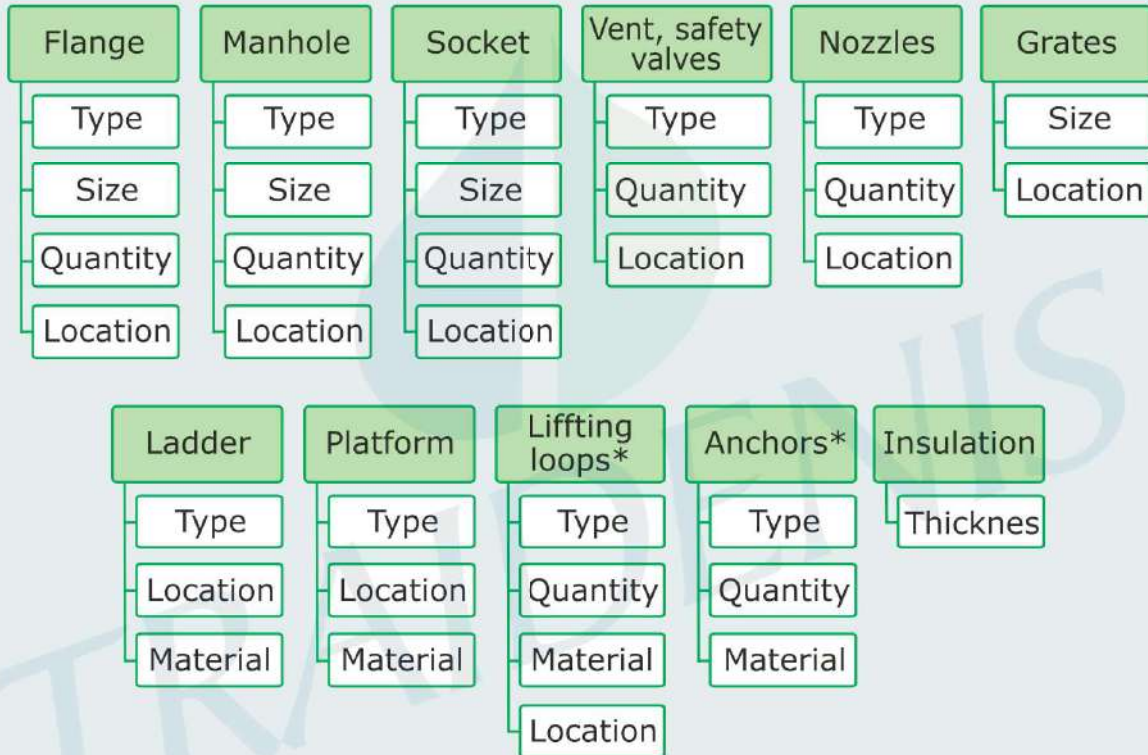

*Manufacturer selects if no information is received from customer.



FIXING LOOPS

1. The material is according to customer's choice.
2. The fixing plates are calculated according to capacity, diameter, height and installation conditions.



MATERIAL:

- AISI 304
- AISI 316

ANCHOR BAND WITH FIXING PLATES ANCHOR BAND WITH ANCHOR BOLTS

1. The material is according to customer's choice.
2. The fixing plates or anchor bolts are calculated according to capacity, diameter, height and installation conditions.

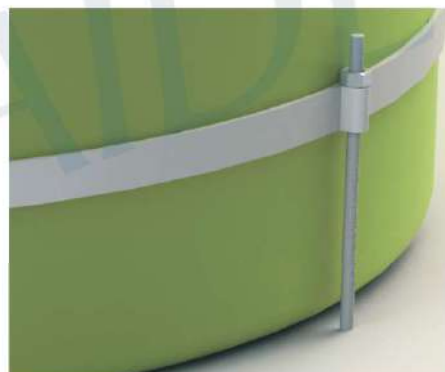
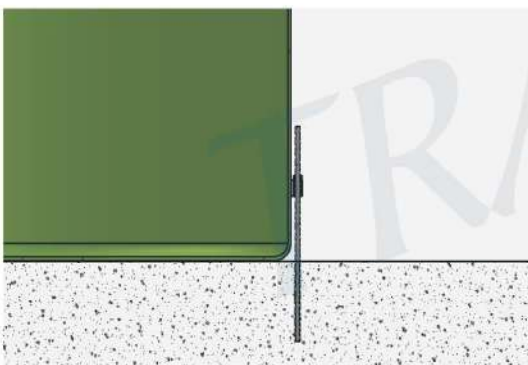

MATERIAL:

- AISI 304
- AISI 316

FOR INSTALLATION
WITH ANCHORS.

SADDLES

SG



GRP saddles

DN1200
DN1500
DN1800
DN2100
DN2400
DN3000
DN3600
DN4000
DN5000



SS



Steel saddles

DN1200
DN1500
DN1800
DN2100
DN2400
DN3000
DN3600
DN4000
DN5000



ST



Saddles for transportation

DN1200
DN1500
DN1800
DN2100
DN2400
DN3000
DN3600
DN4000
DN5000



*Belts are used to keep transportation saddles together with the tank when transposing.
*Transportation saddles and belts are selected by manufacturer.

Application of double wall according to tank's geometry

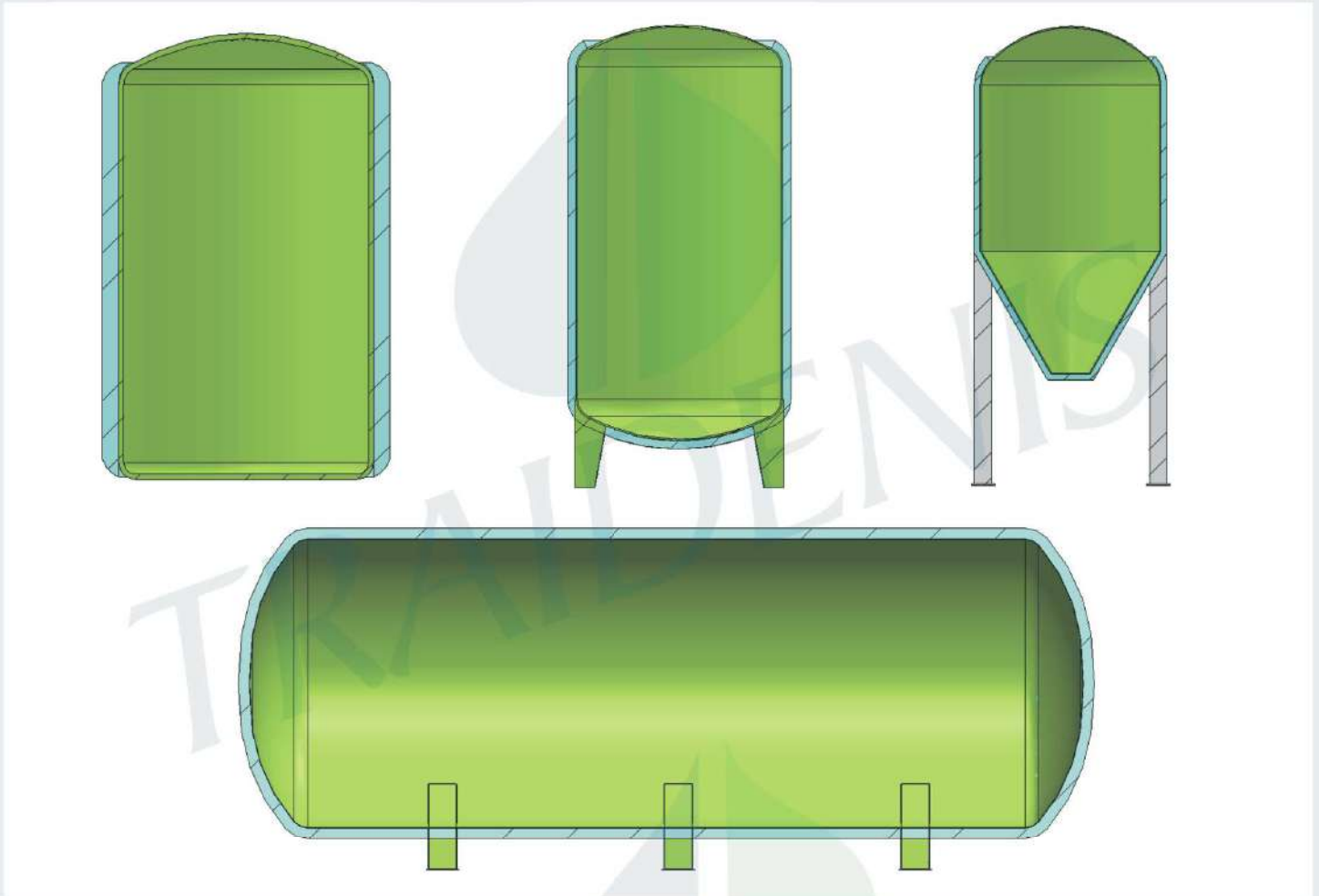

1. Other options with double wall geometry are possible on customer's request.
2. Double wall thickness depends on customer's request.
3. Examples of double walls: DWF, DWFI and DWI (see on page 17).

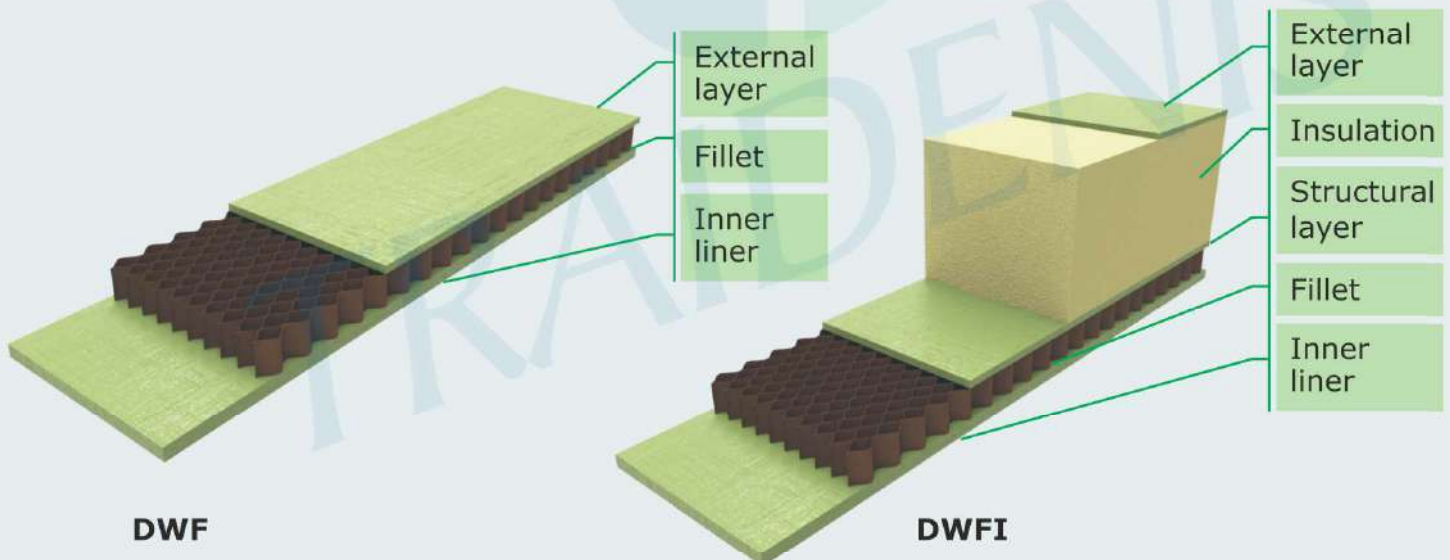

Application of insulation according to tank's geometry

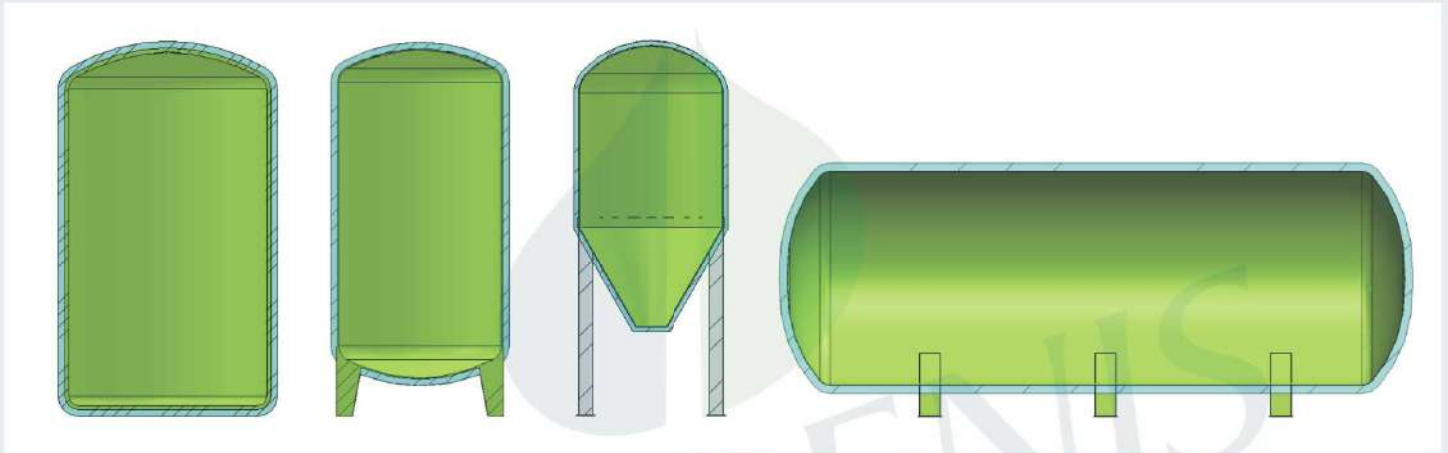

1. Other options with insulation geometry are possible on customer's request.
2. Insulation thickness depends on customer request.

USED MATERIAL:

A RIGID PANEL OF POLYURETHANE FOAM (PIR)

Material characteristics, parameters

Foam symbol	Max. thermal resistance (°C) (PN-93/C-89024)	Max. water absorption (% capacity) (PN-93/C-89084)	Min. closed cell content (%) (PN-ISO 4590)	Foam symbol	Foam density (kg/m ³) (PN-EN1602:1999)	Flammability class (PN-EN ISO 11925, DIN4102)	Max. thermal conductivity (W/mK) (Anacon TCA-8)	Min. resistance to pressing (kPa) (PN-EN826:1998)	
								(parallel to the growth of the block)	(perpendicular to the growth of the block)
S-37	110	1.50%	92%	S-37	37 ± 10 %	E (B-2)	0.026	300	160
S-42	110	1.50%	92%	S-42	42 ± 10 %	E (B-2)	0.026	370	200
S-63	110	1.50%	92%	S-63	63 ± 10 %	E (B-2)	0.026	550	280
S-105	110	1.50%	92%	S-105	105 ± 10 %	E (B-2)	0.035	1000	900

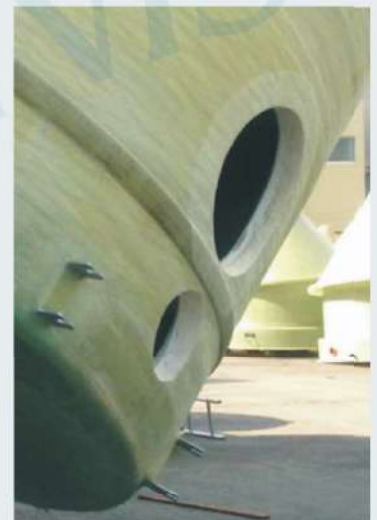
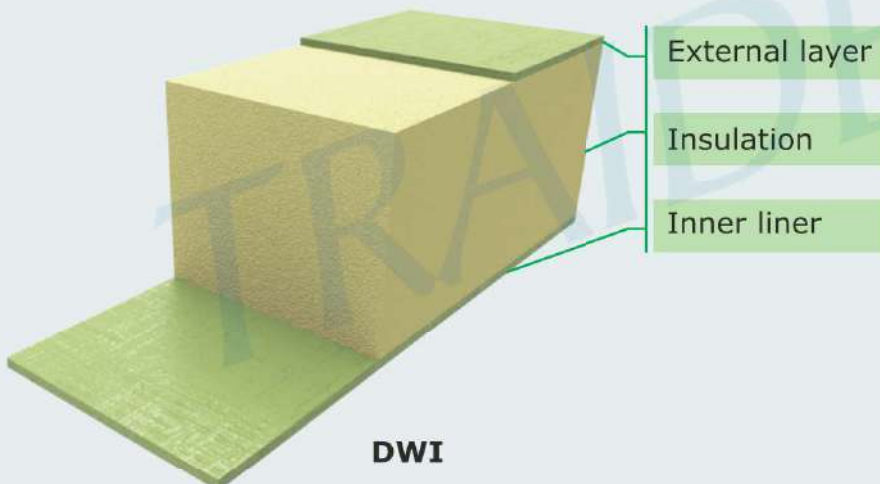

This device is used for electric heating of utility water, designed for fitting into the flanged hole. The heating unit is equipped with ceramic heating elements, operating and safety thermostat. Utility water temperature regulation range 0-75 0C.

Type	Output (kW)	Voltage (V/Hz)	Electrical protection	Temperature settings range (C°)
TPK 210-12/2,2 kW	2.2	1 PE-N-230/50	IP44	0 - 75
TPK 210-12/3-6 kW	3-4-6	1 PE-N-400/50	IP44	0 - 75
TPK 210-12/5-9 kW	5-7-9	3 PE-N-400/50	IP44	0 - 75
TPK 210-12/8-12 kW	8-10,5-12	3 PE-N-400/50	IP44	0 - 75

Electric heater structure

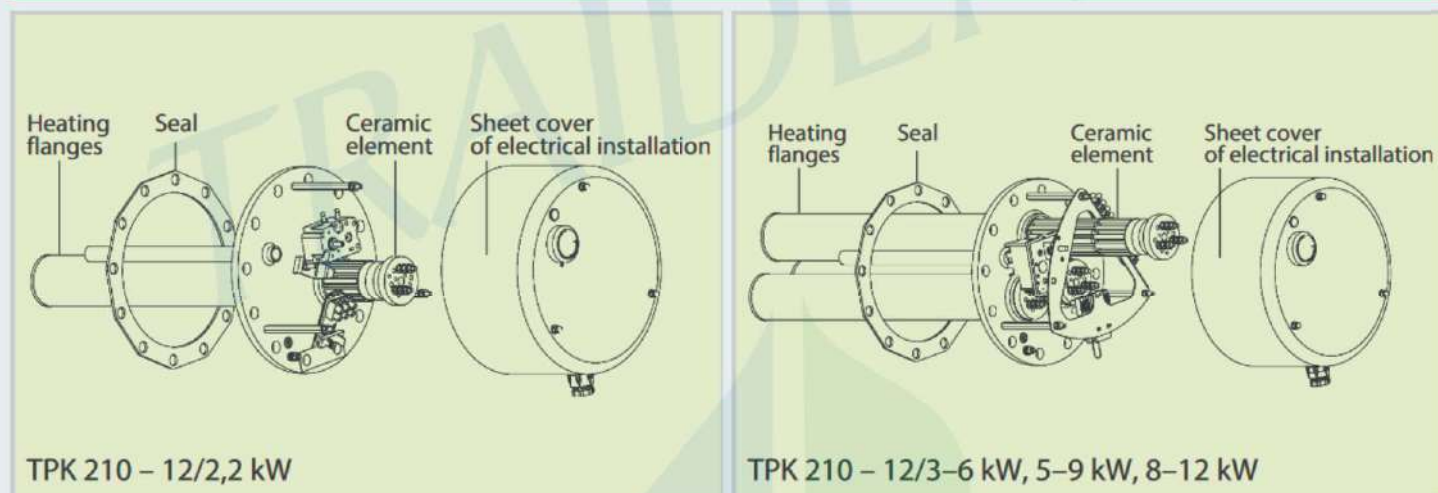

Assembly inside the tank

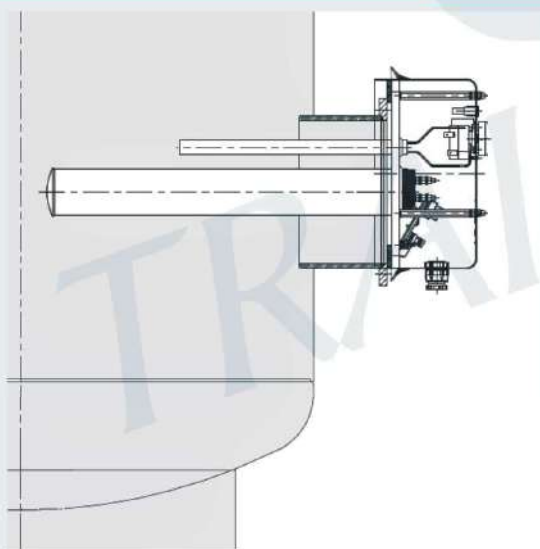

The customer must indicate the heating elements quantity and power.

The heating cable is a self-regulating heating element, which consists of a special polymer mixed with coal. It behaves as a semiconductor. When the temperature decreases the polymer forms numerous conductive channels that way decreasing resistance. As the result current flow raises in the heating cable. Accordingly, as the outside temperature increases the power to the cable is reduced. This allows to maintain the desired temperature.

Parameters:

- From 12 to 1000 V
- Resistance to external temperatures up to 300 °C
- Up to 150 W / m

Application of heating cable according to tank's geometries *

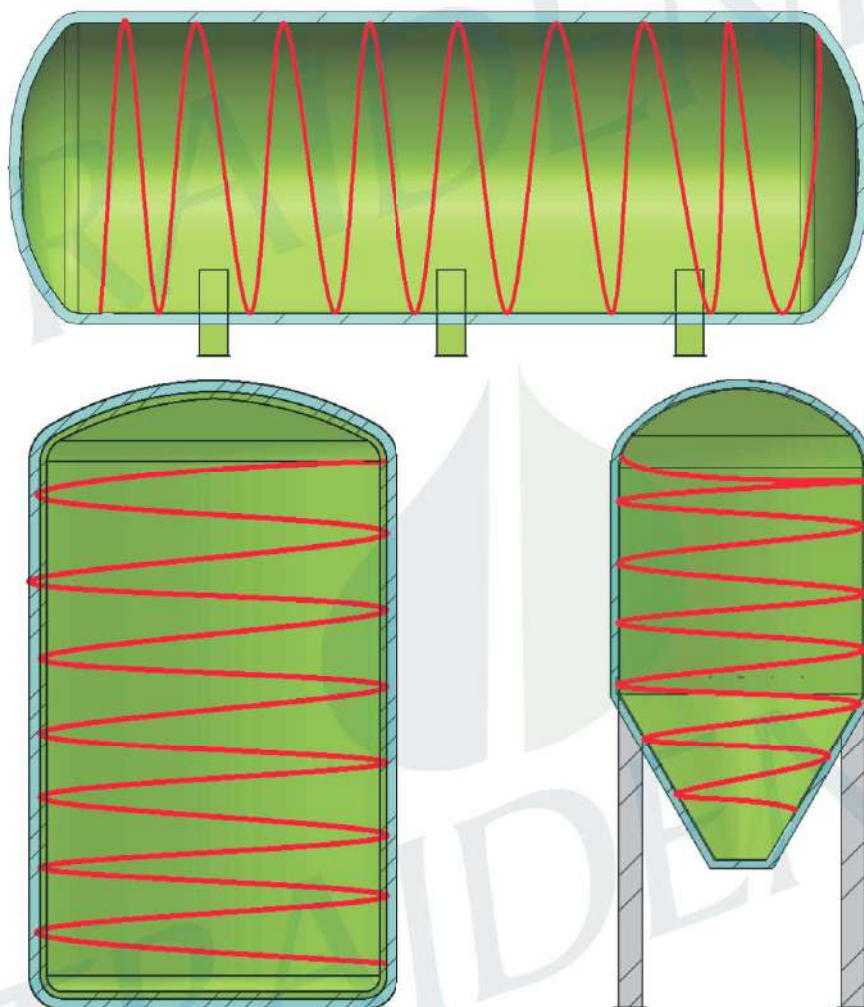

* Spiral winding on cylinders, or on bottoms

The customer must indicate:

- the length and power of heating cable;
- insulation thickness.

COILS HEATING AND TEMPERATURE PERMANENCE

MATERIALS

- PEX (or crosslinked polyethylene)
- stainless steel AISI 304
- stainless steel AISI 316
- special alloy under customer's request

FEEDING PRESSURE

Max 11 bar.

CONFIGURATION*

Single pipes coil in/out

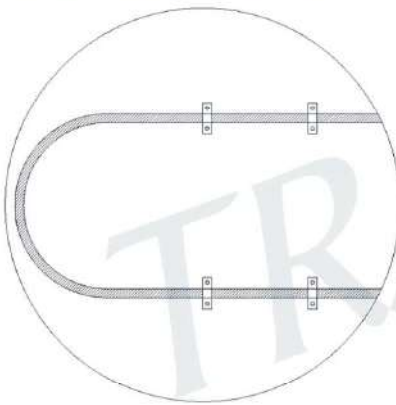

Spiral coils on the bottom

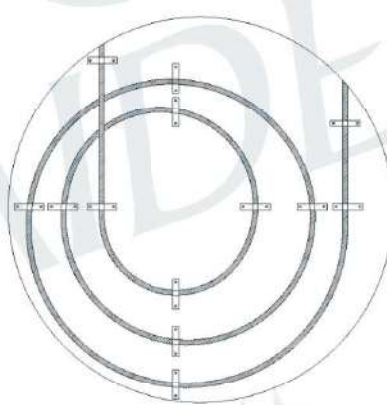

Coils on the bottom

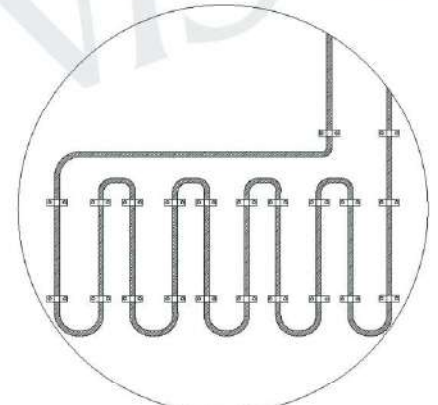

* Other configurations are available on request.

COIL'S INSTALLATION IN THE TANK

PEX coils in the tank are installed with a socket



Other coils in the tank are installed with a flange



COILS HEATING AND TEMPERATURE PERMANENCE

The heating element's length and diameter are according to customer's specifications.

RAILS AND LADDERS

CONFIGURATION

- Ladders with service platform
- Rectilinear service platform
- Service platform according to customer's requirements
- Ladders according to customer's requirements
- Ladders and platforms complex according to customer's requirements

MATERIALS

- | | |
|--------------------|------------|
| - Galvanized steel | - AISI 316 |
| - AISI 304 | - GRP |

STANDARD

Ladders, platforms, handrails are made according to standard EN 14122.



ROOF BASIC DATA

Diameter	Number of segments	Height	Central support
5	7	0.86	
10	14	1.71	
15	20	2.57	+
20	27	3.42	+
25	34	4.28	+
30	41	5.13	+

ROOF MOUNTING TO THE MODULAR TANK

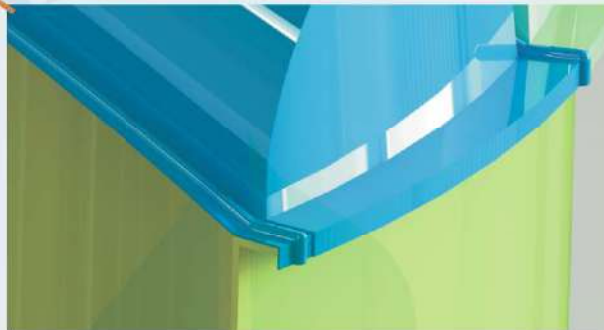

Dome-shaped roof benefits:

- Structural stiffness and strength
- Effective water flow from the roof
- Simple mounting

Central support is needed when diameter is 15 m and more.

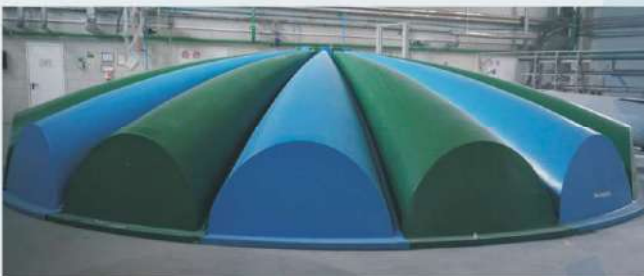

Modular tanks are designed to store

- Drinking water;
- Technical water;
- Wastewater;
- Liquid manure;
- Chemically aggressive liquid.

Benefits

- Manufactured according to individual order;
- Wide size variety (m³, Ø and L);
- Custom panel production possibility;
- High quality materials;
- Easy delivery and installation.



Tank dimensions according to customer's requirements

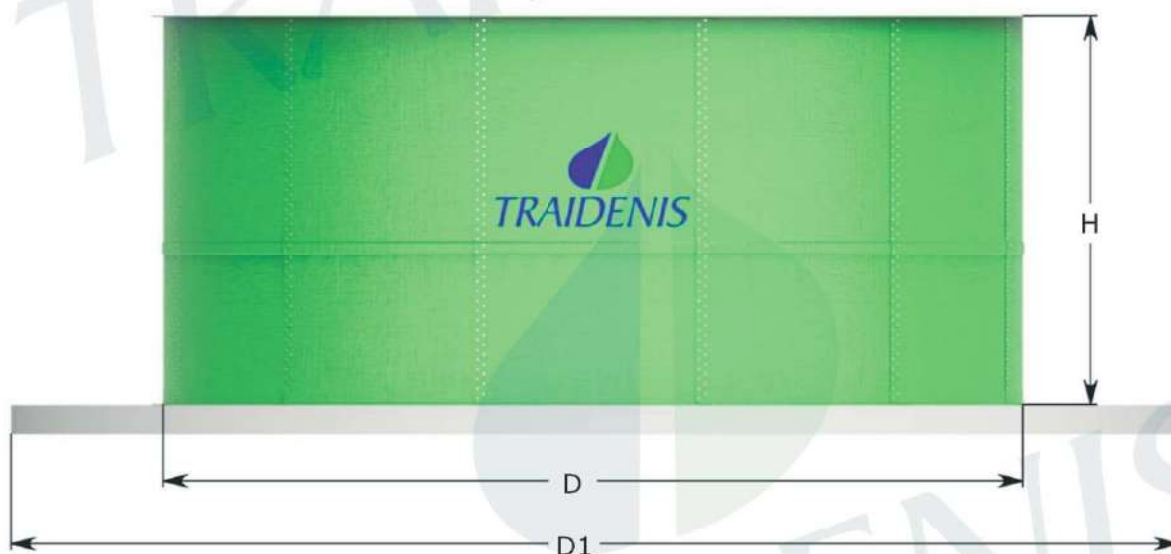

Number of panels	Diameter D (m)	Height H (m)				Concrete surface area D1 (m)
		4,5	5,5	6,5	7,5	
		Volume V (m ³)				
12	8,8	270	333	390	450	10,8
18	13,2	610	750	880	1000	15,2
24	17,6	1090	1330	1570	1810	19,6
30	22	1700	2080	2460	2840	24
36	26,4	2450	3000	3545	4090	28,4
42	30	3180	3890	4600	5300	32

(panel's height (L) can be from 1 to 7,5 m and diameter (Ø) from 8 to 50 m and larger)

Panel types

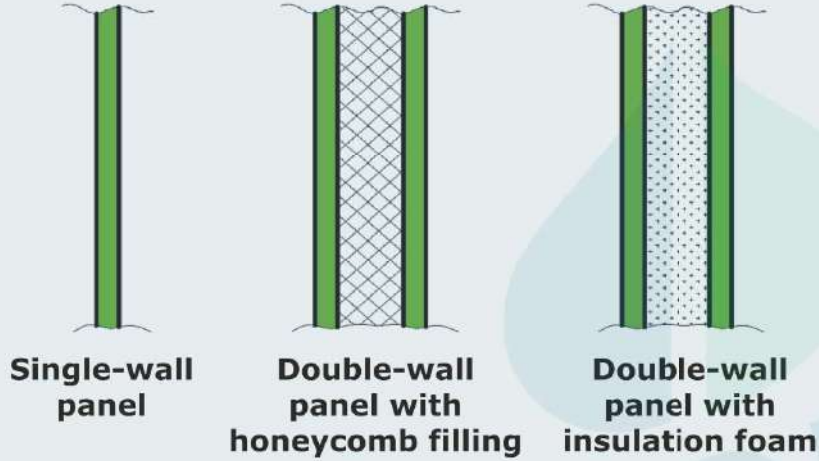

Filling layer thickness according to customer's requirements

Panels connection

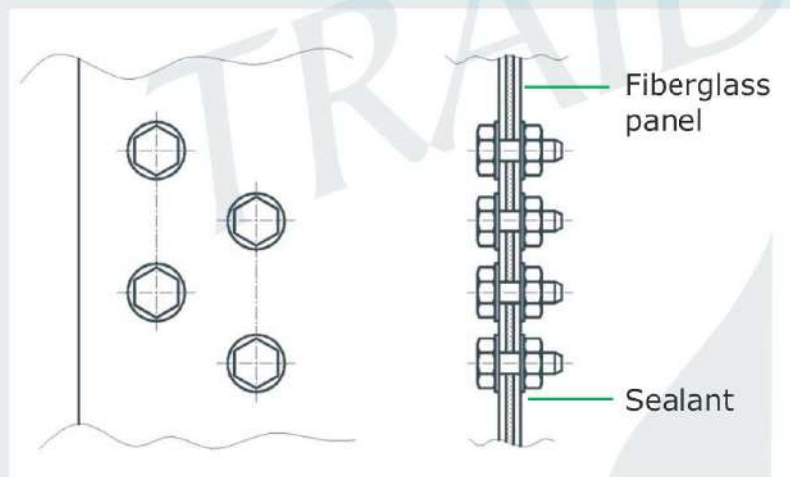

Panels are connected using two rows of screws and special sealant layer.

Installation

Panel is mounted to the steel profile in the concrete base and strengthened by pouring concrete.

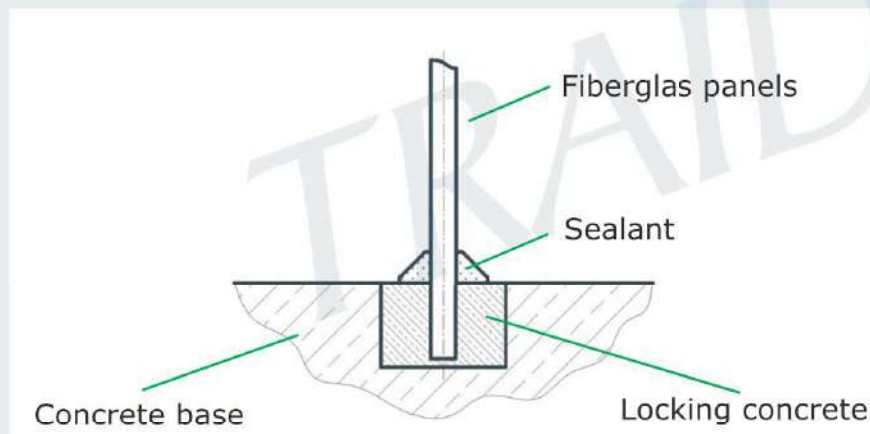

Aquaculture is one of the world's fastest growing economies. Fish farming in closed recirculating systems (CRS) is considered as the most advanced technology of aquaculture.

CRS is a modern complex of equipment, where water circulates in a closed circle and appropriate water level with main parameters is regulated according to the need (necessary oxygen content, temperature, low content of organic admixtures, etc.).

The main advantages:

- Installation of CRS does not require large area of land or great resources of water.
- High efficiency.
- Water saving solution.
- Cultivation is independent from the season.
- Compliance with environmental requirements.
- Biological surveillance is not necessary, as raised species has no possibility to enter adjacent natural water bodies and infringe ecological balance.
- CRS systems are controllable, thus precious fish species may be raised, like European catfish, African catfish, sturgeon, trout, zander, etc.

Offered CRS equipment:

- Biological filters.
- Fish farming reservoirs.
- Additional CRS equipment (air-blowers, sorters, UV lamps, feeders, etc.)

Provided services:

- Selection and designing of CRS systems.
- Fitting of systems.
- Maintenance.
- Consultations.



Closed recirculating system for fish farming

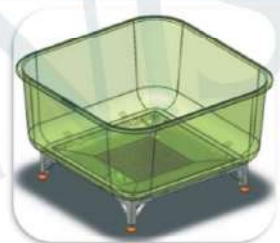
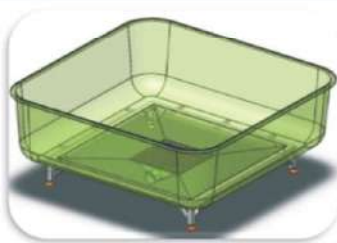

Fish farming reservoirs



GRP MOULDED COVERS

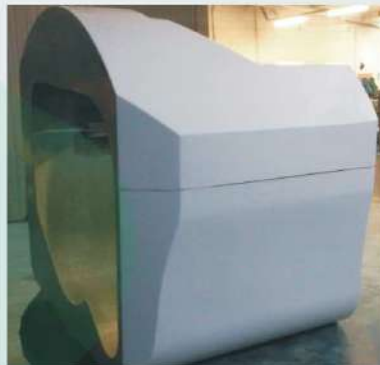

GRP PIPELINES



Tanks can be finished as follows:

TRANSLUCENT

For tanks inside the building or underground



ANY RAL COLOR

For tanks installed outside



LOGOS

Customer's logo, manufacturer's logo, other or none.



Dome - shaped modular roof (DN 21,05 m) for reservoir in Kedainiai, Lithuania.



Production of piping (DN 2 m) according to Danish company order.



Production of 100 m³ modular tank and roof from GRP (DN 6,62 m, H 4,91 m) according to Finnish company order.



Production of scrubber (DN 3,5 m, H 12,5 m) according to Danish company order.



INQUIRY FORM

Date:	
Customer:	
Address:	
Contact person:	
Tel.:	
E.mail:	



DATA PROJECT

Description	Customer data	Standard recommended by Traidenis
Type		See here below
Gross Capacity (m³):		1- 300 m ³
Diameter (mm):		Ø 1000, Ø 1200, Ø 1500, Ø 1800, Ø 2000, Ø 2100, Ø 2400, Ø 3000, Ø 3600, Ø 4000, Ø 4500, Ø 5000 mm
Lenght (mm):		See catalogue

Installation

	Installation (vertical tank)	Installation (horizontal tank)
Customer data	<input type="checkbox"/> Inside <input type="checkbox"/> Outside <input type="checkbox"/> Wind speed <input type="checkbox"/> Snow load	<input type="checkbox"/> Overground <input type="checkbox"/> Underground <input type="checkbox"/> Under roadway <input type="checkbox"/> Green lawn <input type="checkbox"/> Installation depth

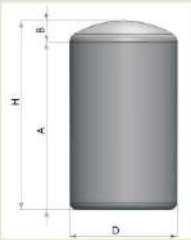
Tank geometries

<input type="checkbox"/> Vertical tank		<input type="checkbox"/> Dished top <input type="checkbox"/> Flat bottom <input type="checkbox"/> Slope bottom (angle <input type="checkbox"/>) <input type="checkbox"/> Open top <input type="checkbox"/> Flat top <input type="checkbox"/> Slope bottom (angle <input type="checkbox"/>)	
<input type="checkbox"/> Vertical tank with legs		<input type="checkbox"/> Dished top <input type="checkbox"/> Dished bottom <input type="checkbox"/> Open top <input type="checkbox"/> Flat top <input type="checkbox"/> Slope bottom (angle <input type="checkbox"/>)	<input type="checkbox"/> GRP legs <input type="checkbox"/> Metal frame <input type="checkbox"/> GRP skirt
<input type="checkbox"/> Conical bottom silos		<input type="checkbox"/> Dished top <input type="checkbox"/> Open top <input type="checkbox"/> Flat top <input type="checkbox"/> Slope bottom (angle <input type="checkbox"/>)	<input type="checkbox"/> GRP legs <input type="checkbox"/> Metal frame <input type="checkbox"/> GRP skirt

Horizontal overground tank

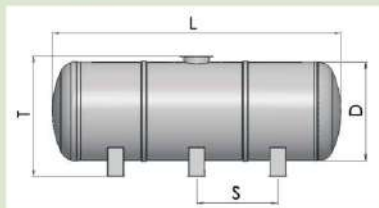

Saddles*

GRP
 Steel

Horizontal underground tank

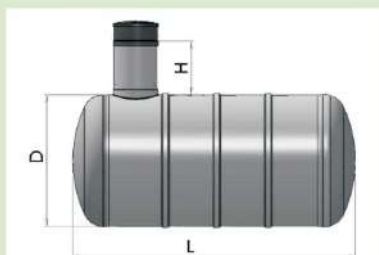

Fluids

Description	Customer data
Density (kg/dm ³)	
Working temperature (°C)	
Design temperature (°C)	
Working pressure (mbar)	

Finishing

Description	Customer data
Finishing (RAL)	<input type="checkbox"/> Translucid <input type="checkbox"/> RAL

Types of sandwiches

<input type="checkbox"/> Single wall	<input type="checkbox"/> Double wall	<input type="checkbox"/> Double wall with insulation	<input type="checkbox"/> Insulated	<input type="checkbox"/> Insulated, heating cable
--------------------------------------	--------------------------------------	--	------------------------------------	---

Rails and ladders

Description	Material
<input type="checkbox"/> Rails	<input type="checkbox"/> Galvanized steel
<input type="checkbox"/> Ladders	<input type="checkbox"/> AISI304
<input type="checkbox"/> Service platform	<input type="checkbox"/> AISI316
	<input type="checkbox"/> GRP

TRAIDENIS

Pramones str. 31 B,
LT62175 Alytus, Lithuania

Tel. +370 315 78 263
Fax. +370 315 77 729

info@traidenis.lt
www.traidenis.com

